

Article number: 021816011256

Description: Clamp with bracket and rubber
SPGU 6011. 256/30 SK

Measures

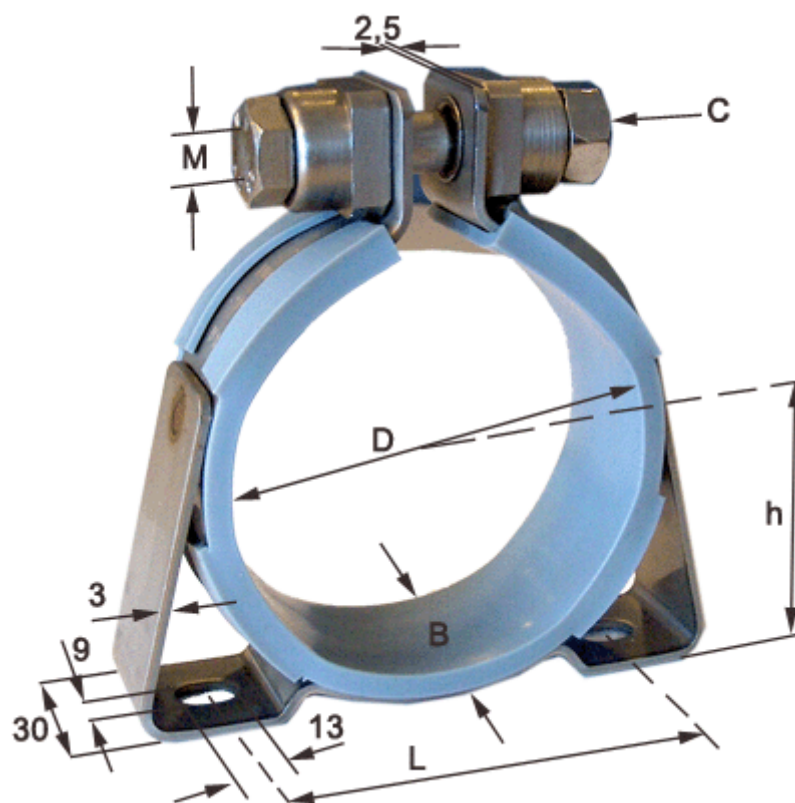

C (screw type) = SK hexagon screw

Diameter D = 256

h = 136

L = 248

Width B = 30